

**STAR  
THE  
EMPIRE  
STRIKES BACK  
WAR**

**HOTH ICE PLANET  
ADVENTURE  
SET**



**WE REALLY DO CARE**

In your **Hoth Ice Planet Adventure Set**, every part is important. If any part is missing or broken, we will, as a service to you, replace it free of charge.

Simply check the part (or parts) that you need, cut this coupon out and send it to:

- 771-602**
- ELEVATOR REAR
  - ELEVATOR FRONT
  - ACTION LEVER
  - SNAPPER ARM
  - SNAPPER CAP
  - ACTION STAND
  - ELEVATOR GUIDE RAILS
  - ACTION BUTTON
  - PEGS (4)
  - RADAR DISH
- 771-603**
- TURRET RIGHT SIDE
  - TURRET LEFT SIDE
  - LOWER BASE
  - UPPER BASE

NAME \_\_\_\_\_

ADDRESS \_\_\_\_\_

CITY \_\_\_\_\_ STATE \_\_\_\_\_ ZIP \_\_\_\_\_

**KENNER PRODUCTS**  
1014 VINE STREET  
CINCINNATI, OHIO 45202  
ATTN. CONSUMER RELATIONS

**DON'T FORGET TO INCLUDE  
YOUR NAME, ADDRESS AND ZIP CODE**

**PARTS LIST**

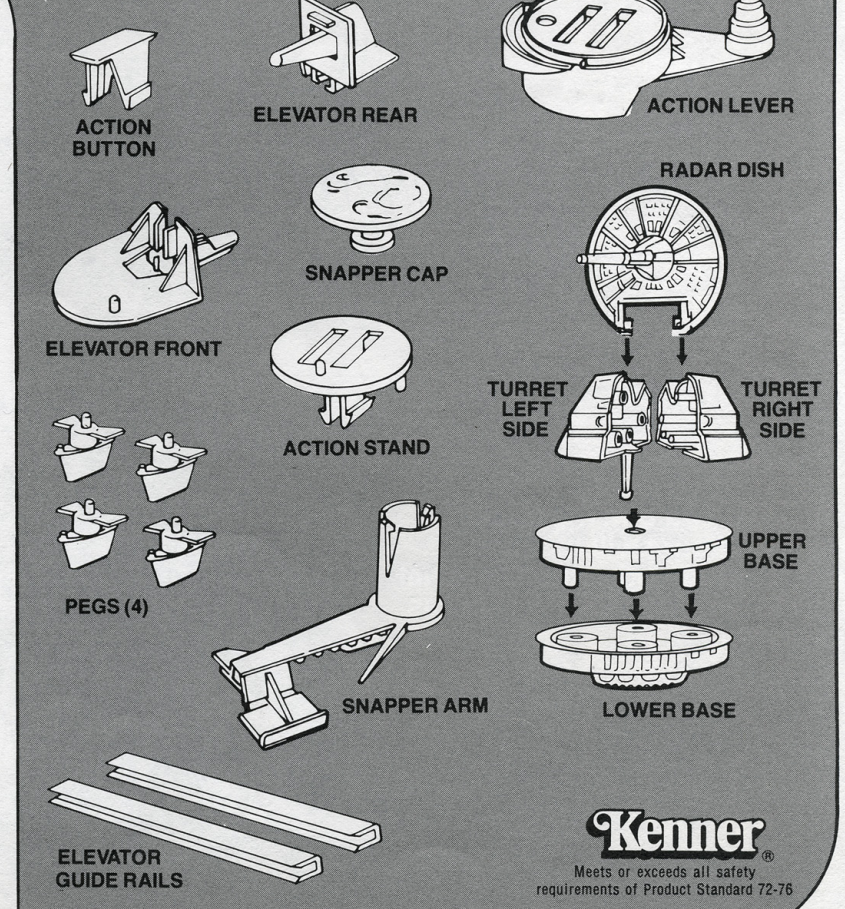

**HOTH ICE PLANET™**

Have Mom or Dad help you!

**A. BASE ASSEMBLY**

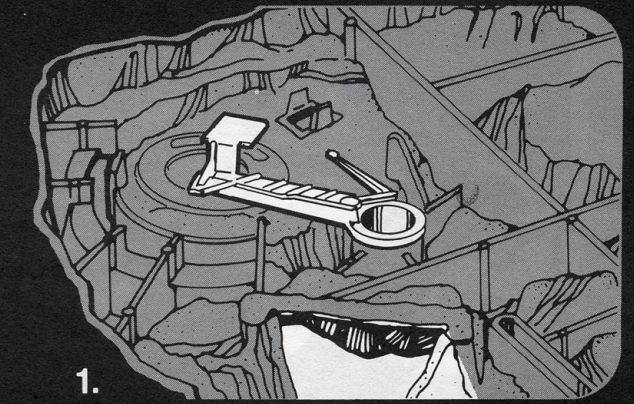

1. Turn toy over and position **Snapper Arm** under base as shown.

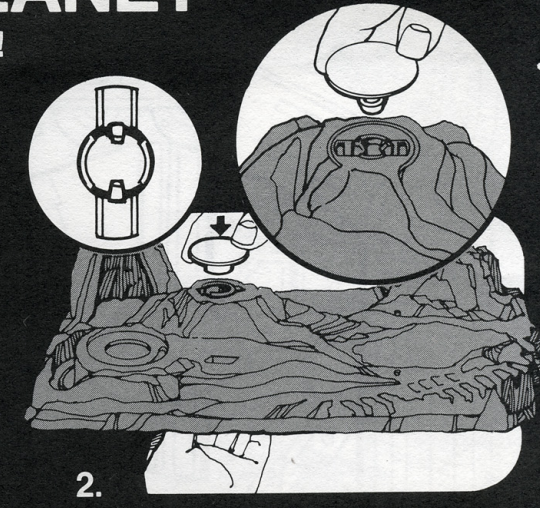

2. Hold the **Snapper Arm** in place, turn the toy over, secure the **Snapper Arm** by popping the **Snapper Cap** on top of base.

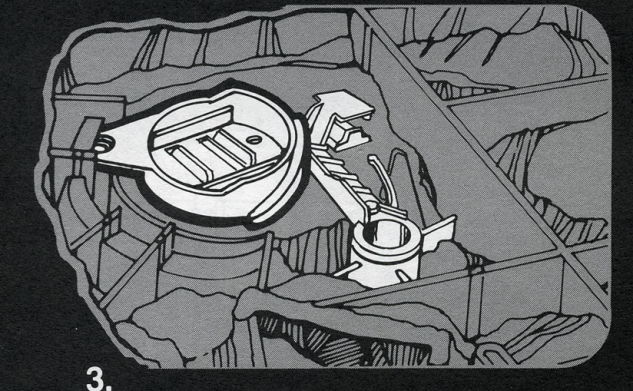

3. Install **Action Lever** under base as shown. Handle fits through slot.

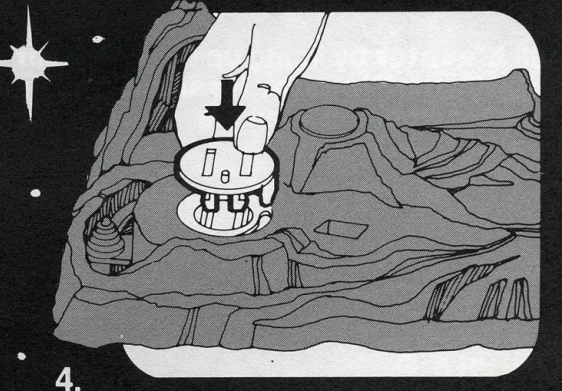

4. Hold the **Action Lever** in place—turn toy over, line up pin in **Action Stand** with hole in **Action Lever**. Push **Action Stand** into place.

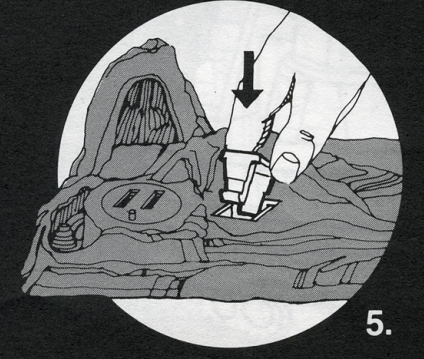

5. Start one side first and press **Action Button** into slot.

**B. HOTH ICE PLANET™ BACKDROP**

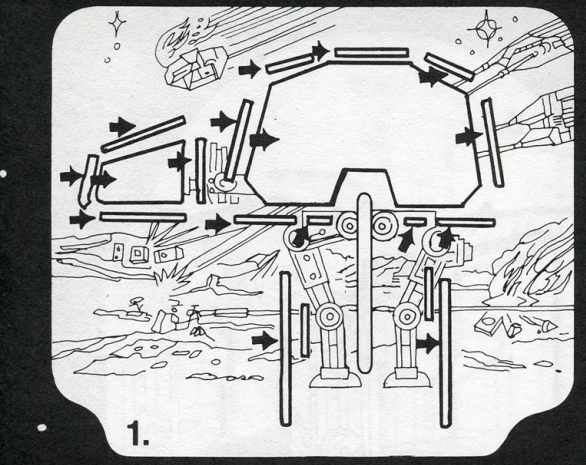

1. Push out pre-cut holes.

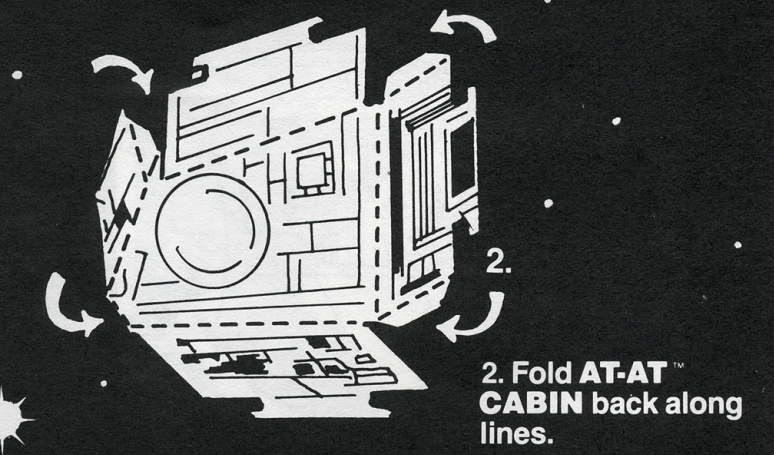

2. Fold **AT-AT CABIN** back along lines.

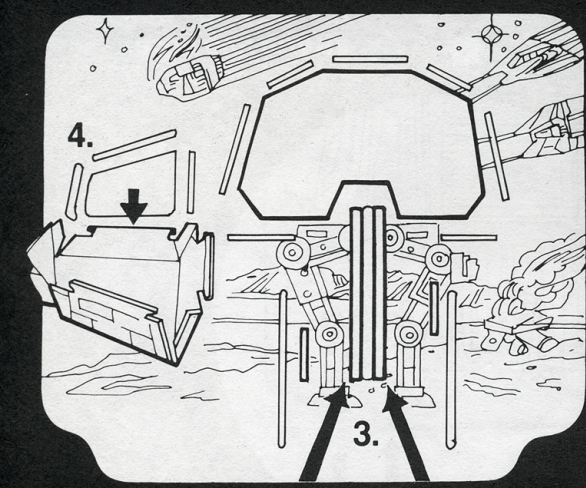

3. Put **Elevator Guide Rails** in **HOTH ICE PLANET LANDSCAPE** as shown.

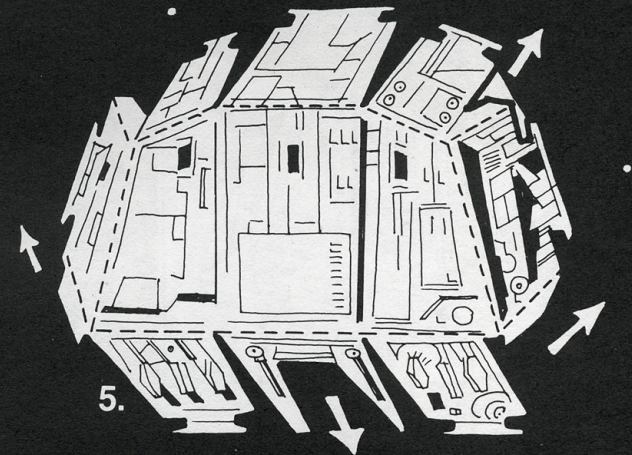

4. Push bottom tab into slot. Then insert other tabs.

5. Fold body back along lines.

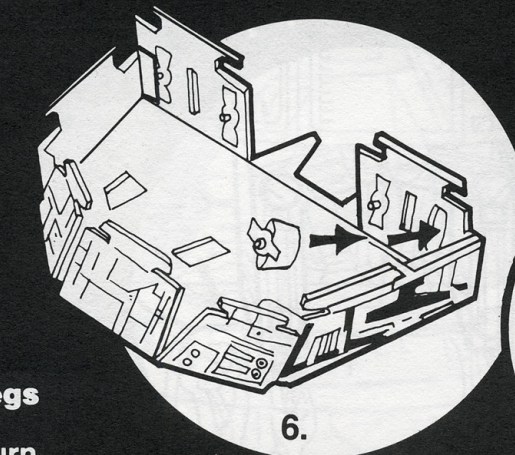

6. Put in **Action Pegs** for **Action Figures**. Turn  $\frac{1}{4}$  turn to lock.



## B. HOTH ICE PLANET BACKDROP continued

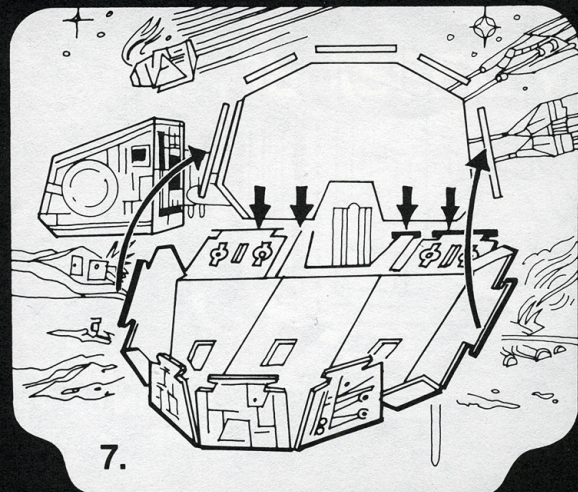

7. Push bottom tabs into slots. Then fold up and push remaining tabs in.

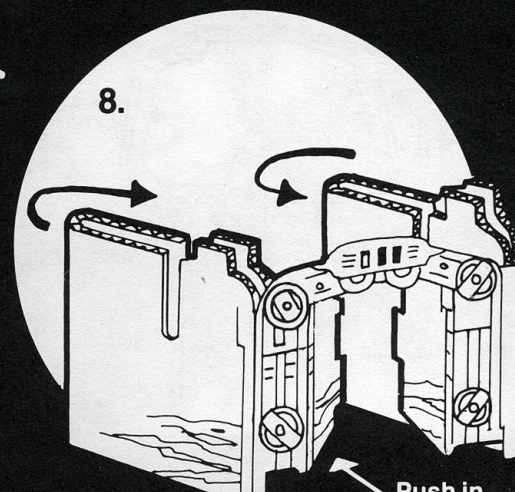

8. Fold body base as you see here.

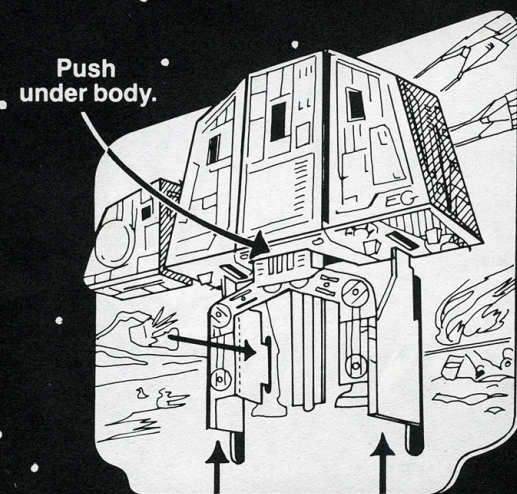

9. Insert tabs into body then push up into place.

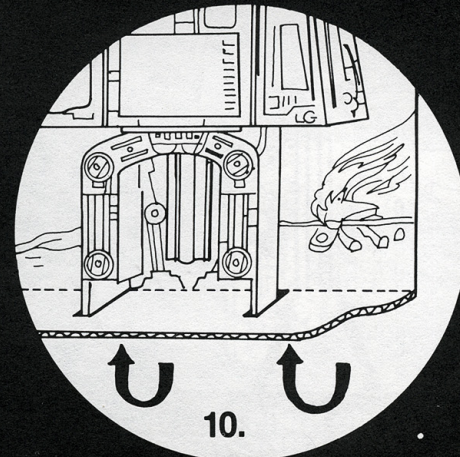

10. Fold bottom of Backdrop up to lock.

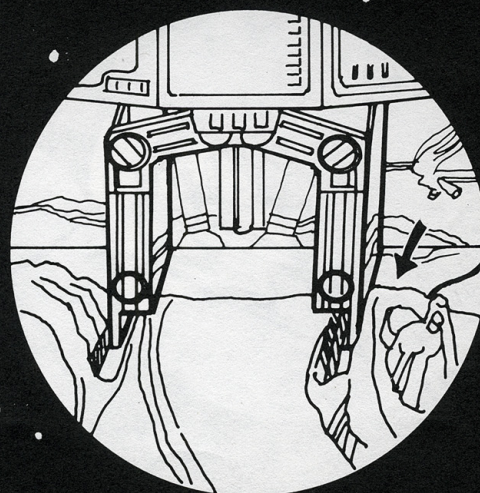

11. Fit Backdrop into ICE PLANET as shown.

## C. ELEVATOR ASSEMBLY

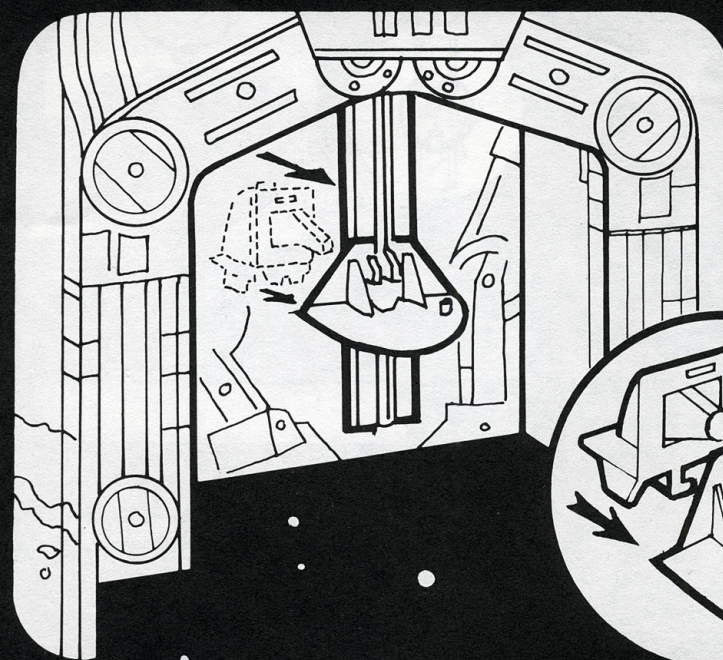

### DO NOT PUT ELEVATOR TOGETHER FIRST!

Install Elevator by lining up the Elevator Front with the Elevator Rear and pushing the two together between the Elevator Guide Rails.

### RADAR LASER CANNON

Radar dish swivels and tilts to simulate action adventures and pick up enemy signals.



## D. RADAR LASER CANNON

Tilt into hinge holes one at a time.

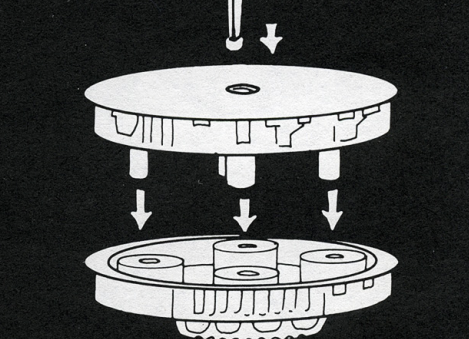
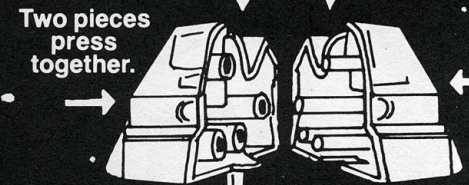
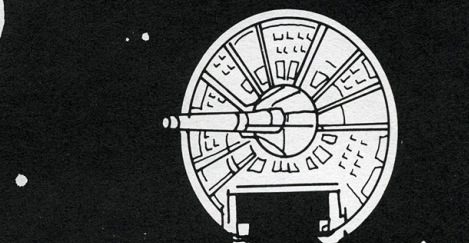
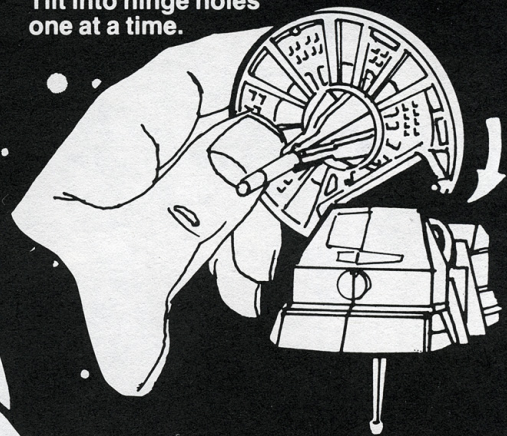

Radar Laser Cannon fits together easily, just press parts together.

## ACTION ADVENTURES

### A. BATTLE ACTION LEVER

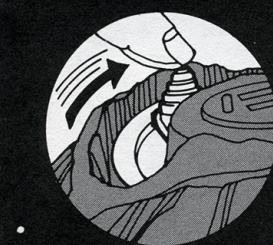

1. Move lever to back of track to start your adventure.

2. Stand STAR WARS™ Action Figure on peg. Place Imperial Snow Stormtroopers™ on button.



2.



3. Move lever along the track. Attacking figure will turn and simulate stunning action. Imperial Snow Stormtroopers™ will fall as if captured.

### B. ELEVATOR

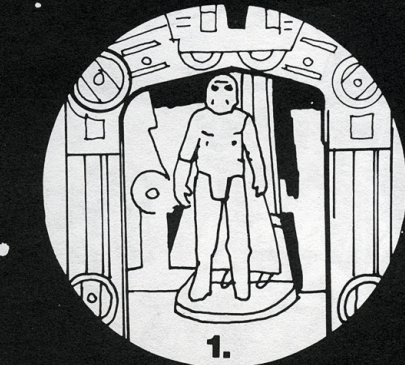

1. Stand Imperial Snow Stormtrooper™ or other STAR WARS™ Action Figure on elevator peg.

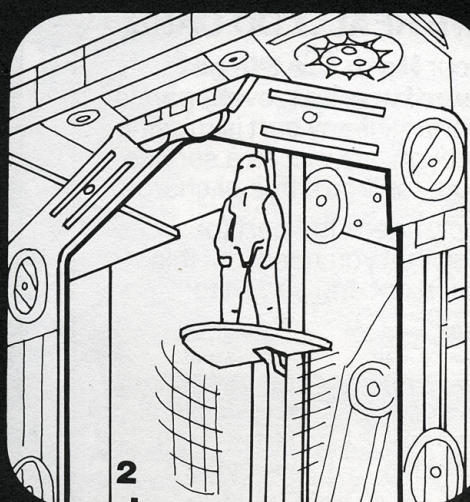

2. Move elevator up transporting Action Figures into the AT-AT™.

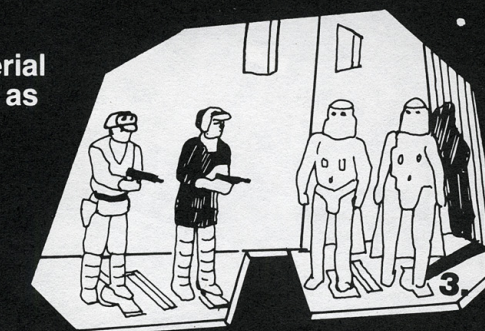

3. You can stand figures on pegs inside vehicle. Figures not included.

™ TRADEMARK OF LUCASFILM LTD. (LFL) ©1977, 1978, 1980 LUCASFILM LTD. (LFL) CPG Products Corp., a subsidiary of General Mills, Inc. by its Division Kenner Products, Cincinnati, Ohio 45202