

BEWARE OF THE SWAMP!

Pretend to lose your Action Figure and cargo.

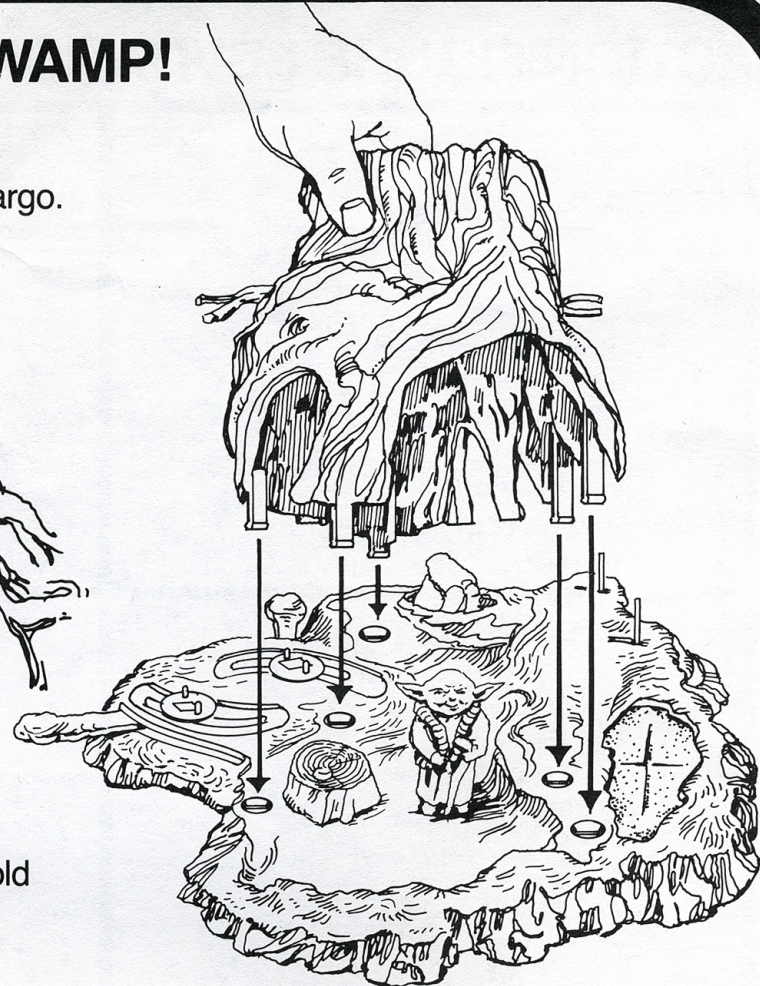
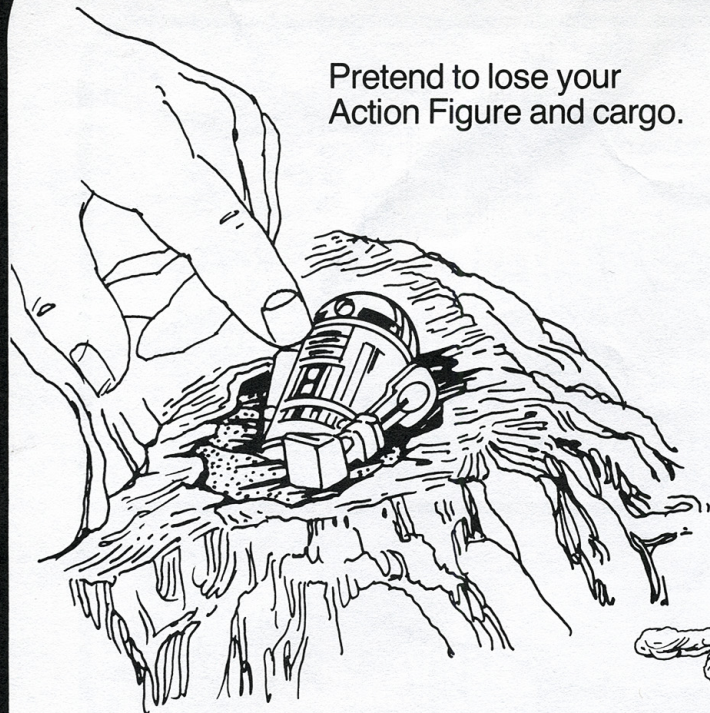

Stump is removable for added play, hold base and lift stump.

To replace, press tabs into slots.

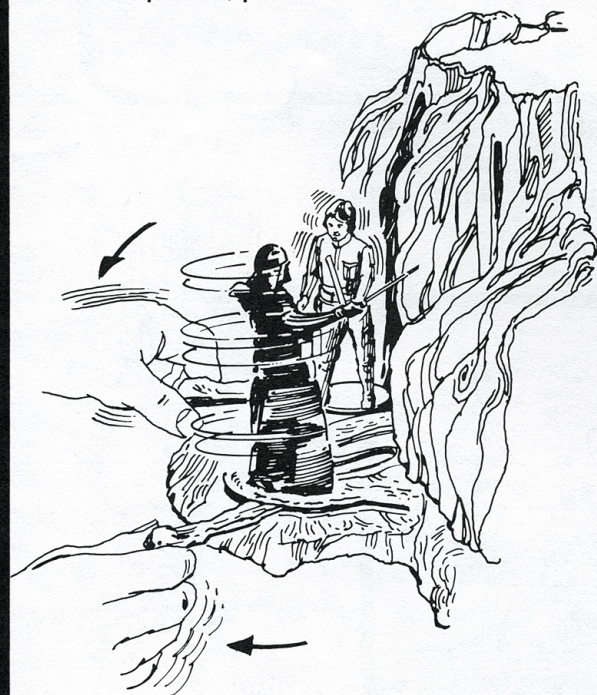

Recreate the mysterious Lightsaber battle Luke has with the imaginary Darth near the hollow tree.



Yoda taught Luke to use the Force to levitate objects, R2-D2, and even himself during his training on Dagobah.

1050-013



DAGOBDAH ACTION PLAYSET

ASSEMBLY INSTRUCTIONS

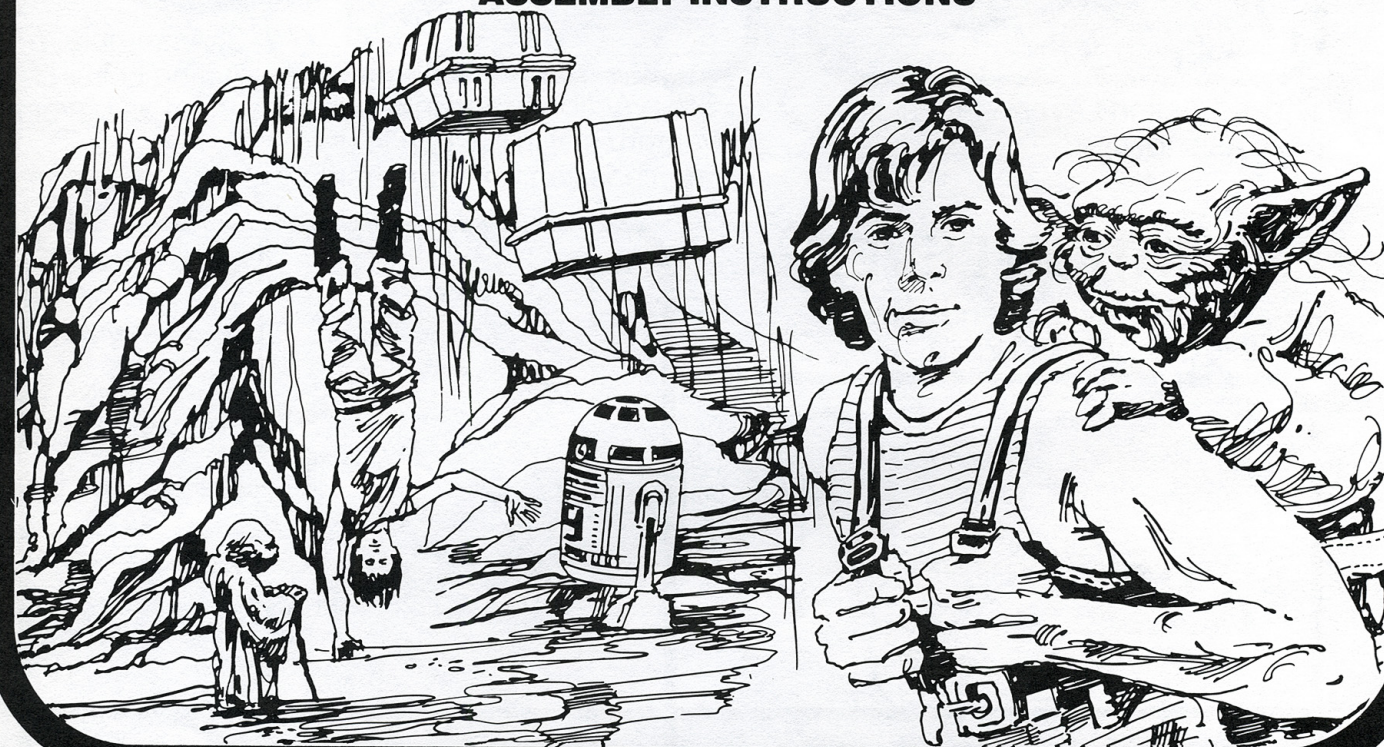

WE REALLY DO CARE

We make each toy with lots of tender loving care ... so, if something seems to be wrong, please read the instructions again carefully. If any part is missing or broken when you receive your toy, we will, as a service to you, replace it free of charge.

Please identify the name of any missing part (or parts) by using the instruction sheet description. Simply fill out the form provided and send it along with the broken part to:

KENNER PRODUCTS
1014 VINE STREET
CINCINNATI, OHIO 45202
Attn: Consumer Relations



KENNER PRODUCTS
1014 VINE STREET
CINCINNATI, OHIO 45202

3rd CLASS MAIL

NAME _____

ADDRESS _____

CITY _____

STATE _____ ZIP _____

NAME OF MISSING PART(S) _____ DAGOBDAH ACTION PLAYSET

PLEASE RETURN BROKEN PART(S)

©1981 LUCASFILM, LTD. (LFL) TRADEMARK OWNED BY LUCASFILM, LTD. (LFL) AND USED BY KENNER UNDER AUTHORIZATION.
CPG Products Corp., a subsidiary of General Mills, Inc. by its Division Kenner Products, Cincinnati, Ohio 45202

ACTION LEVERS



1. Insert Action Lever A thru slot in base as shown.

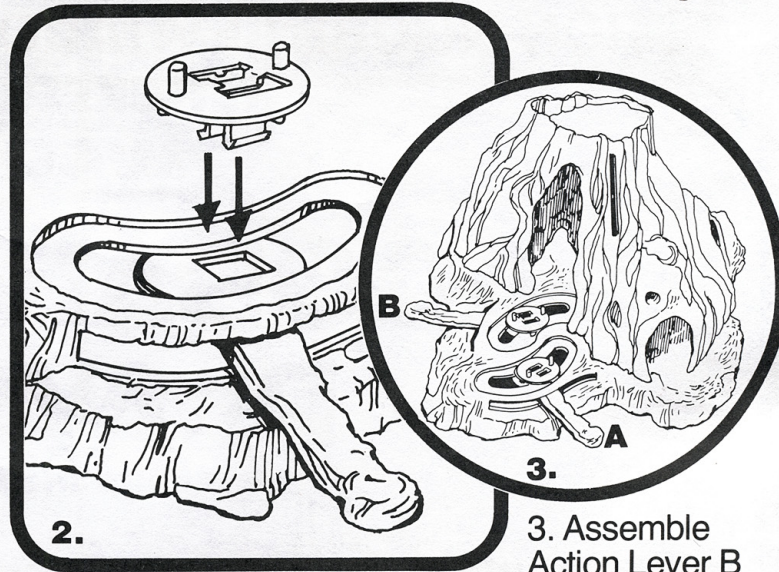

2. Snap Action Stand into Action Lever thru slot in base. (Hold lever in position from underside.)

3. Assemble Action Lever B same as Lever A.

LEVITATION LEVER

Bend ends of lever up and snap lock into place. (1 and 2)

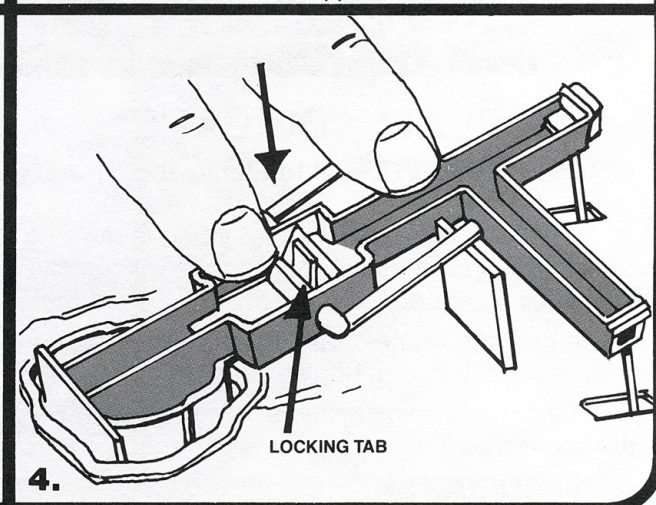
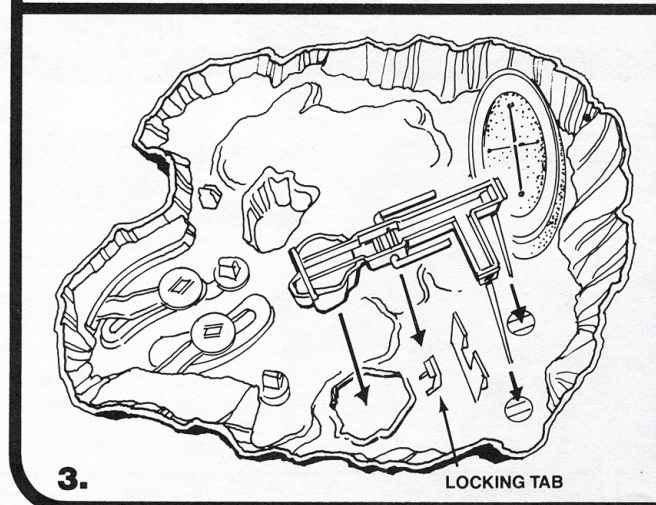
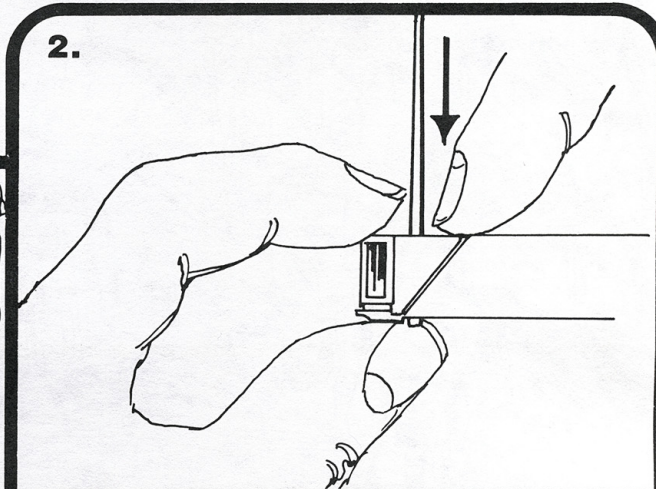
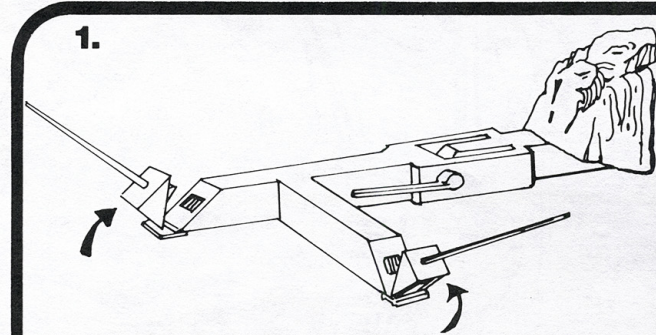

Place lever on underside of base and lock into place by pressing lever over locking tab. (3 and 4)

ACTION FIGURE LEVITATION LEVER

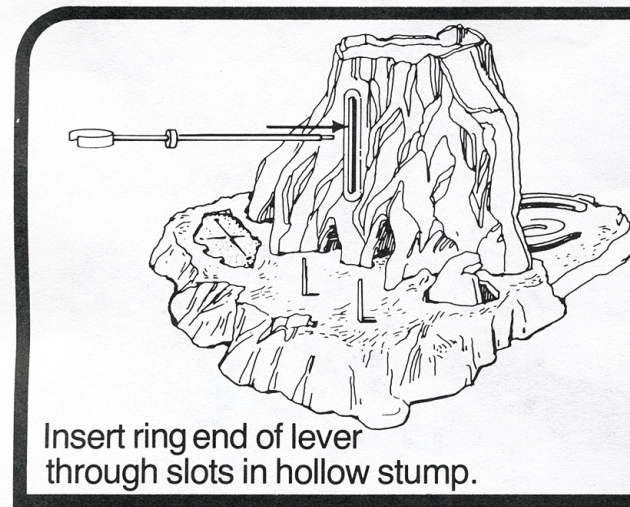

Insert ring end of lever through slots in hollow stump.

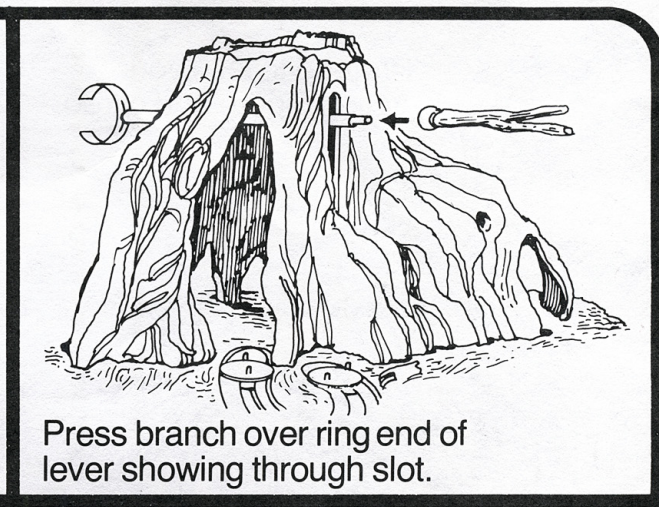

Press branch over ring end of lever showing through slot.



Press Action Figure into ring.

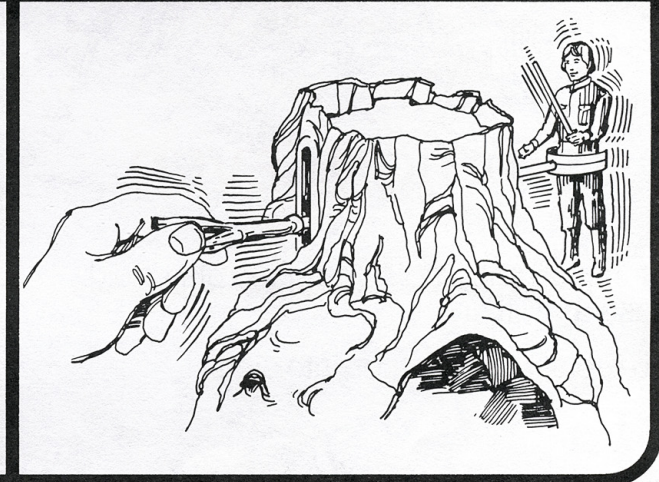

To levitate Action Figures. Raise and rotate the lever from the other side of the stump.

LEVITATING OBJECTS

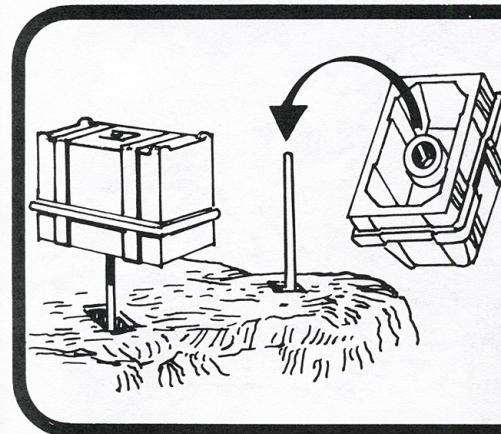

To levitate objects, place cargo boxes over posts and press lever.

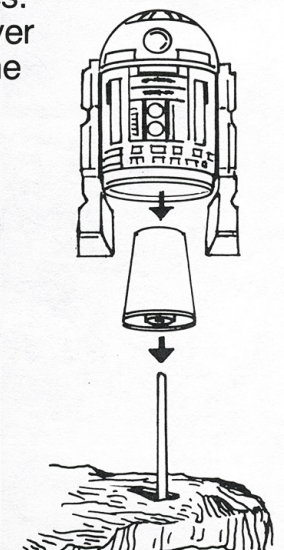
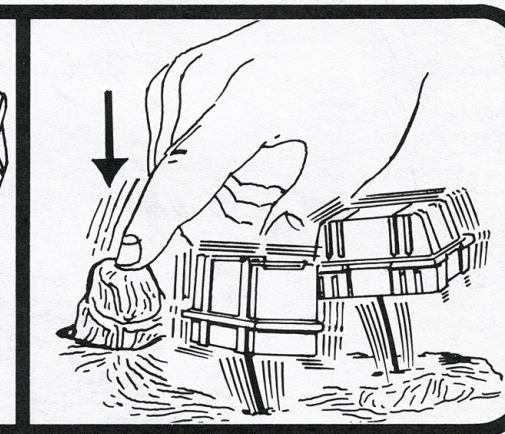

To levitate R2-D2 place adapter over post and R2-D2 over adapter.