

Imperial Stormtroopers™ are transported to the spot where Luke Skywalker™ and Ben Kenobi™ were last seen in the Movie.

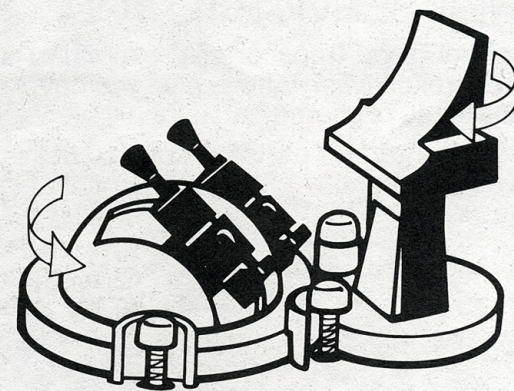

The moving laser cannon spins a full 360° and moves up and down. Control it by moving the RADAR DISH in the opposite direction.

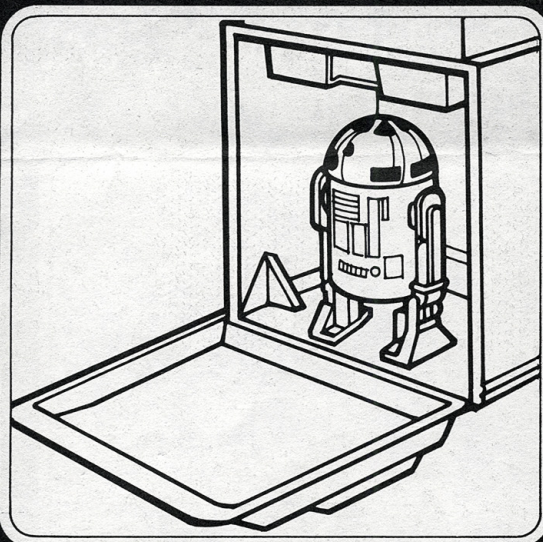

A special rear compartment is used to transport captured droids. It looks like Artoo Detoo (R2-D2)™ has been caught.

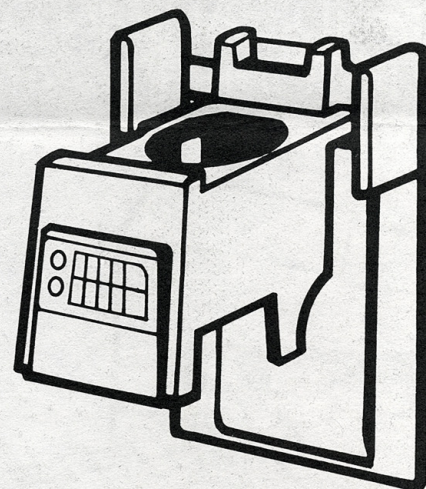

Prisoners wear PRISONER IMMOBILIZATION UNITS over their heads. Stormtroopers use them to try to brainwash those loyal to the rebels.

YOUR IMPERIAL TROOP TRANSPORTER™ AND REAL STAR WARS MOVIE ACTION SOUNDS HELP YOU CREATE YOUR OWN STORIES AND SCENES.
MAY THE FORCE BE WITH YOU™.

STAR WARS™

©TWENTIETH CENTURY FOX FILM CORPORATION

IMPERIAL TROOP TRANSPORTER™

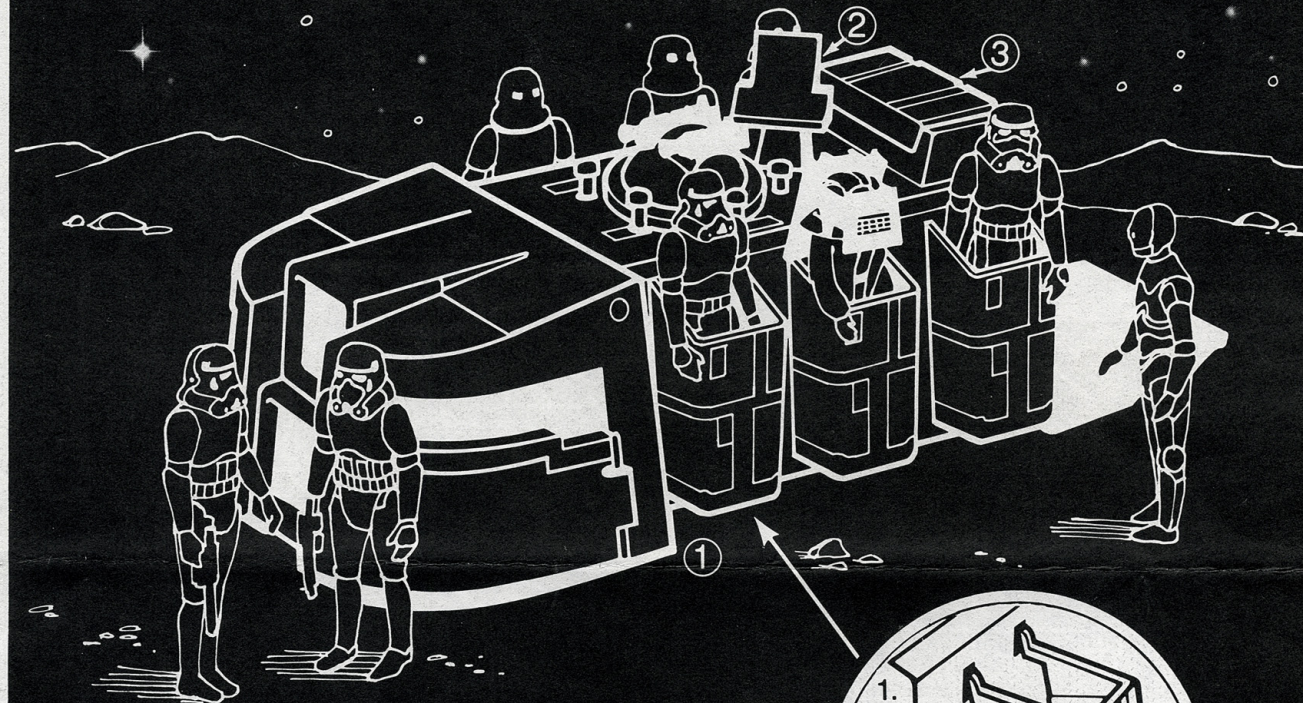

ASSEMBLY INSTRUCTIONS

1. First, attach the six PERSONNEL PODS by inserting the tabs on the top of the pods into the slots on the side of the toy. Then, snap the lower tab into place.

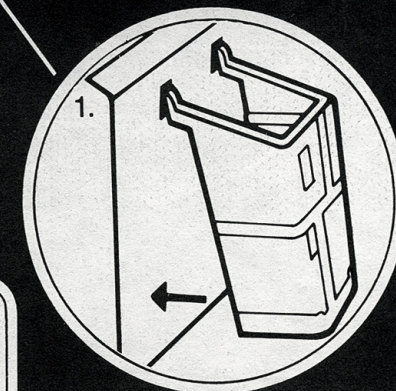

2. The RADAR DISH simply snaps onto the rotating RADAR BASE.

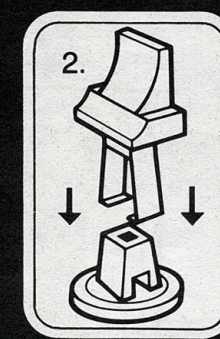

3. Insert one "C" ALKALINE BATTERY (not included) as shown. Battery Compartment is shown by ③ on top of toy. Notice one end of the battery compartment has a narrow channel for the battery tip.

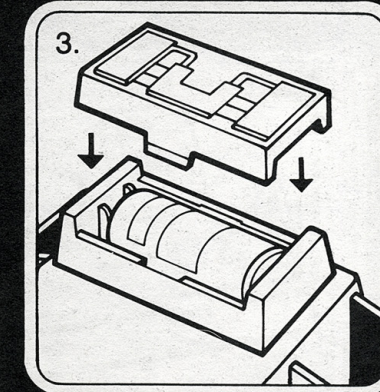

Snap the BATTERY COVER into place.

Put on your labels, using your package and this sheet as a guide.

Kenner

©CPG PRODUCTS CORP. 1979 by its Div.
 KENNER PRODUCTS, Cincinnati, Ohio 45202

AUTHENTIC STAR WARS MOVIE SOUNDS ARE FILLED WITH ACTION AND ADVENTURE.

To activate the sound, select one SOUND CONTROL button. PRESS DOWN AND HOLD IT DOWN FOR A MOMENT. THEN RELEASE.

The Imperial Troop Transporter features six different sounds from the original STAR WARS motion picture.

Put on your labels, using your package and this sheet as a guide.

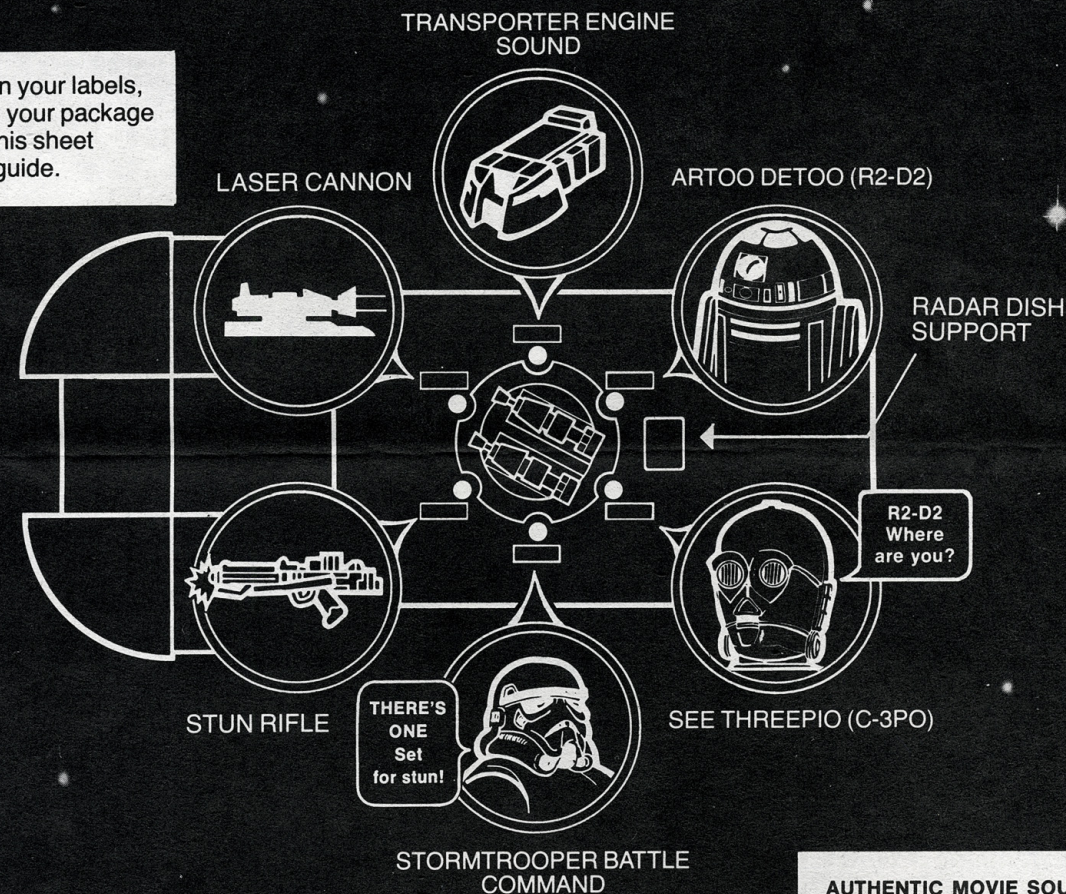

THERE'S ONE Set for stun!

AUTHENTIC MOVIE SOUNDS
To activate the sound, select one SOUND CONTROL button. PRESS DOWN and HOLD IT FOR A MOMENT. THEN RELEASE.

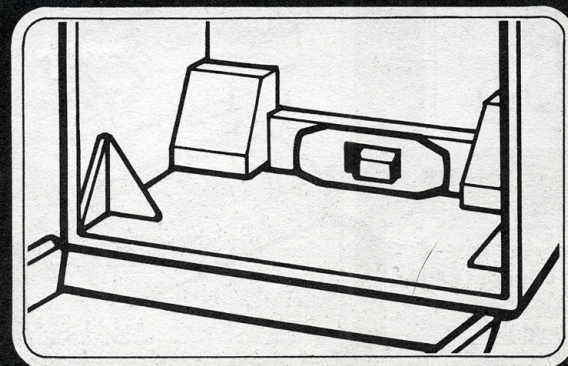

This switch makes the voices go faster or slower. The switch is located inside the rear compartment of your Imperial Troop Transporter.

ANOTHER SERVICE TO YOU

In your Imperial Troop Transporter™, every part is important. If any part is missing or broken when you receive your toy, we will, as a service to you, replace it free of charge.

Simply check the part (or parts) you need, cut this coupon out and send it to:

KENNER PRODUCTS
1014 VINE STREET
CINCINNATI, OHIO 45202
ATTN: CUSTOMER RELATIONS

- PERSONNEL POD
- LABELS
- RADAR DISH
- BATTERY COVER
- PRISONER IMMOBILIZATION UNIT
- LASER CANNON
- PILOT DOOR (RIGHT)
- PILOT DOOR (LEFT)
- REAR COMPARTMENT DOOR

NAME _____

ADDRESS _____

CITY/STATE _____

ZIP _____

DON'T FORGET TO INCLUDE YOUR NAME, ADDRESS AND ZIP CODE.

OUR FRIENDS ARE IN DANGER WHEN IMPERIAL STORMTROOPERS™ ARE ON PATROL.

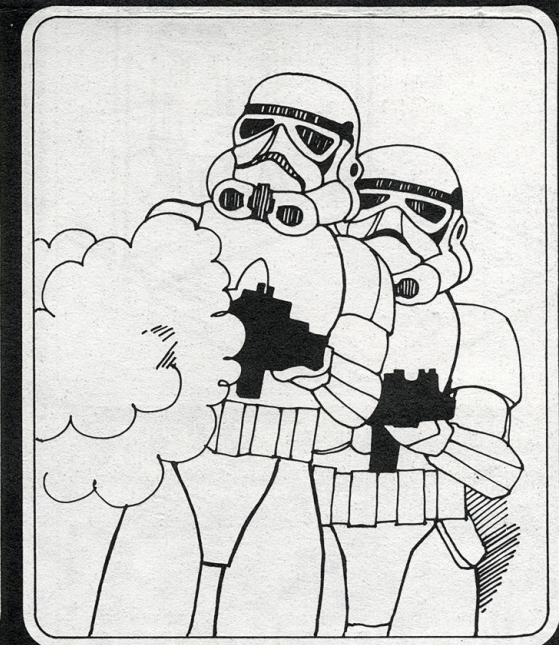
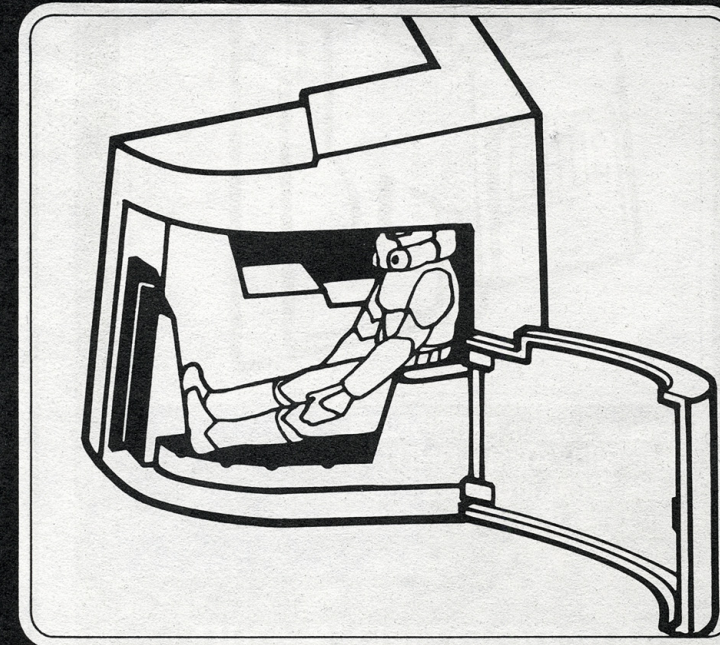

Doors to front pilot and co-pilot compartments open. Action figures (not included) such as Imperial Stormtrooper™, Death Star Commander™ or Death Star Droid™ might be at the controls.



Darth Vader's™ final orders crackled through each Trooper's headset. The words were chillingly clear, "Either come back with the plans or don't come back at all!"

It seemed impossible! Two mindless *droids*™ had made off with design prints of the Empire's most devastating weapon...*Death Star!*™

As the search squad left the Imperial Cruiser, a report came through from the on-board Scanning Stations. The *droids'* Escape Pod had been tracked to an arid region on Tatooine known as the Central Lowlands. The exact ground position had been lost as the Pod went beyond the Scanner's range, but, in all that sand, a metal Pod should not be hard to find, not with the *Imperial Troop Transporter!*™

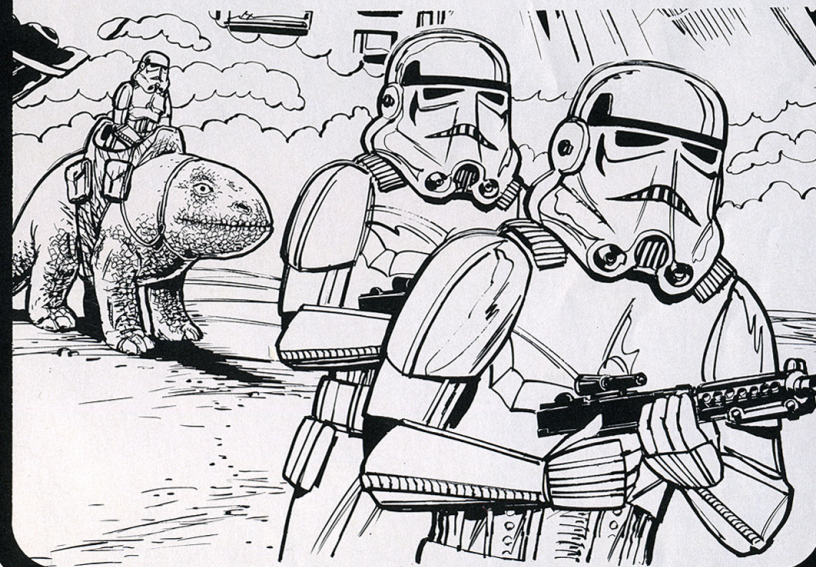

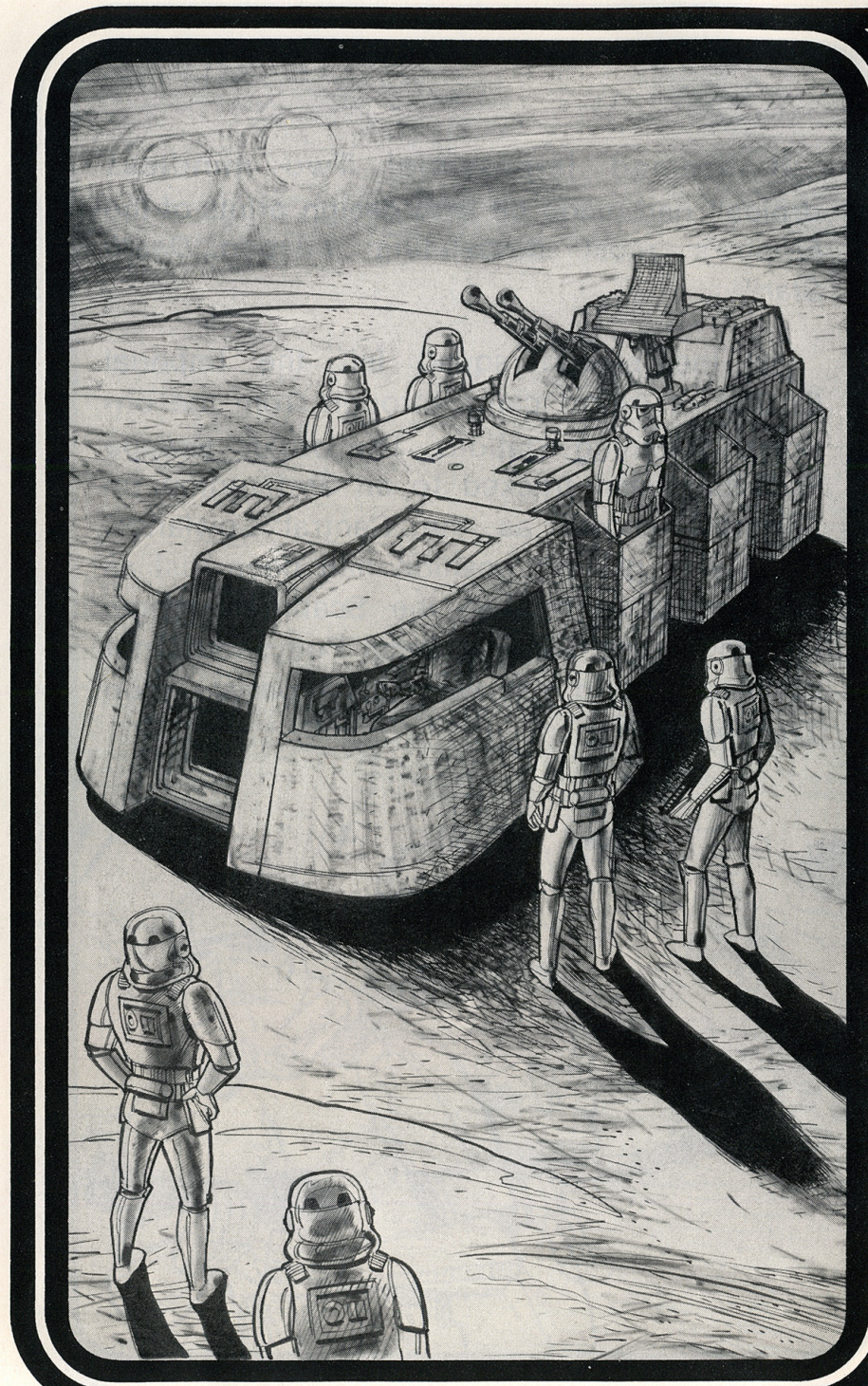

Landing at pre-set coordinates, the *Troop Transporter of the Imperial Empire* was there to meet them...long, sleek, deadly, with the Imperial Crest over the side hatches. The great, steel blue craft was operated by two drivers and could hold all six members of the search squad. Each Trooper entered a Traveling Rack on the side of the Transporter. They rode standing up in individual racks since their white and black armor made it almost impossible to sit. The rear of the vehicle contained a Prisoner Immobilization Unit for the detention and taming of renegade droids. And, for heavy resistance, there was always the Laser Blaster mounted on the upper deck. Even at night, the Transporter looked fearsome with the glare of its black, flip-up lights.

One driver reported that *Dewback*[™] ground units had spotted the Pod just a short distance to the north. Not bad for a *Dewback* outfit! But, the Transporter would take over the search from that point. It could cover twice the distance in half the time.

The Transporter hovered a few feet above the surface and sped to the Pod landing sight, but the droids and the plans had long since gone. They

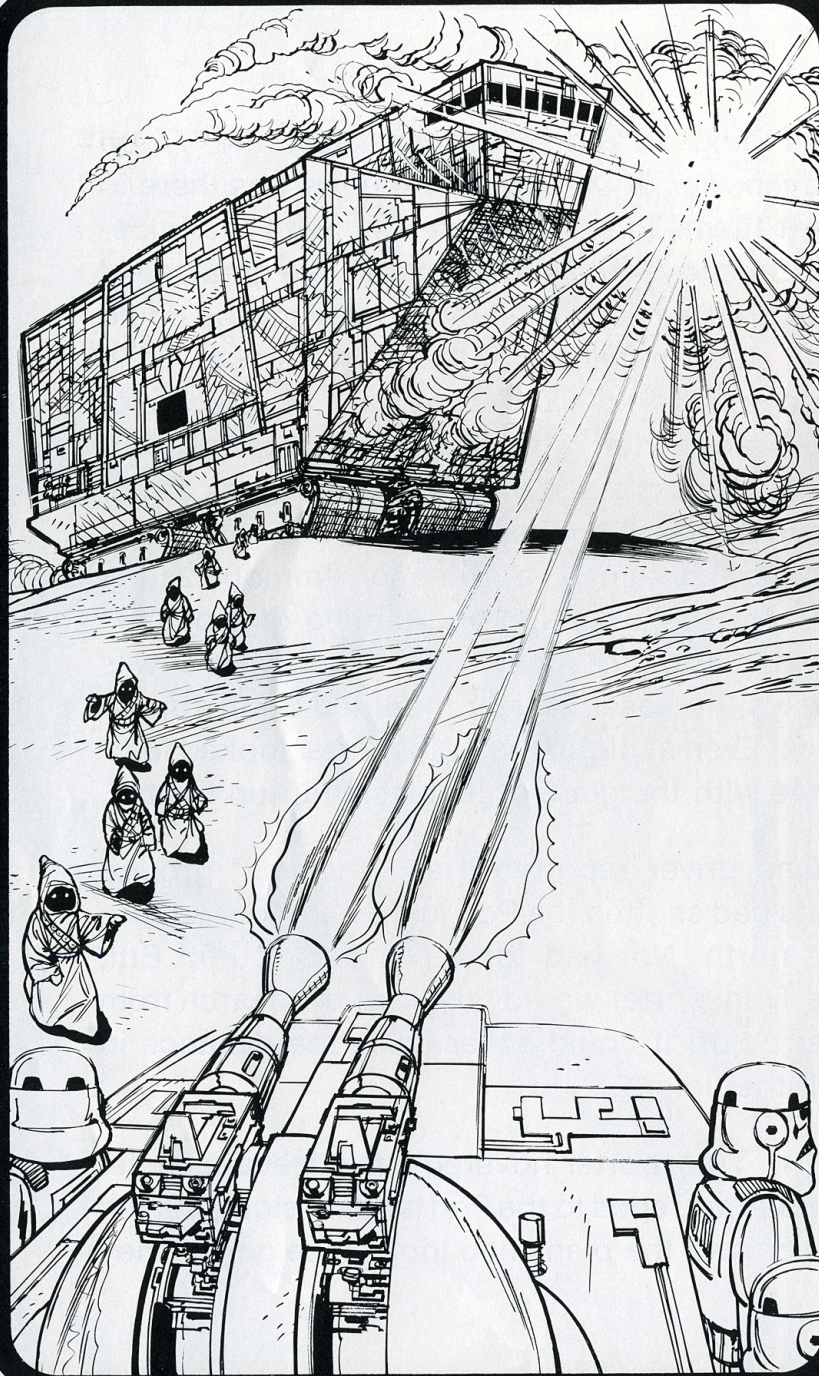

left only two sets of tracks in the sand that were spared by the mid-day winds. The *Dewback* had already gone after one set of tracks. The Transporter locked onto the other set and headed east.

The Surface Scanner in the Transporter soon picked up an old Class "D" transport slogging through the sand. Something the *Jawas*[™] called a *Sandcrawler*[™]. Over the external sound system, they were ordered to halt in the name of the Empire. They kept moving. Two rounds were fired across the *Sandcrawler* bow from the 50 megatome Blaster on the upper deck. The *Jawas* stopped and came out to greet the Imperial boarding party.

They had many *droids* in their inventory, but not the ones *Darth Vader* wanted back. Two *droids* were looted from the cargo bay and placed in the *Droid Prisoner Compartment* for further "questioning". A sale had been recorded to one Owen Skywalker of two *droids* for his moisture farm. That's all the Troop Commander had to hear. The order was given to open fire and the *Jawas* were cut down in mid-step... defenseless.

As the *Transporter* left to find the Skywalker farm, the heavy gun fired once at the Sandcrawler's mid-section. It exploded and burst into flames.

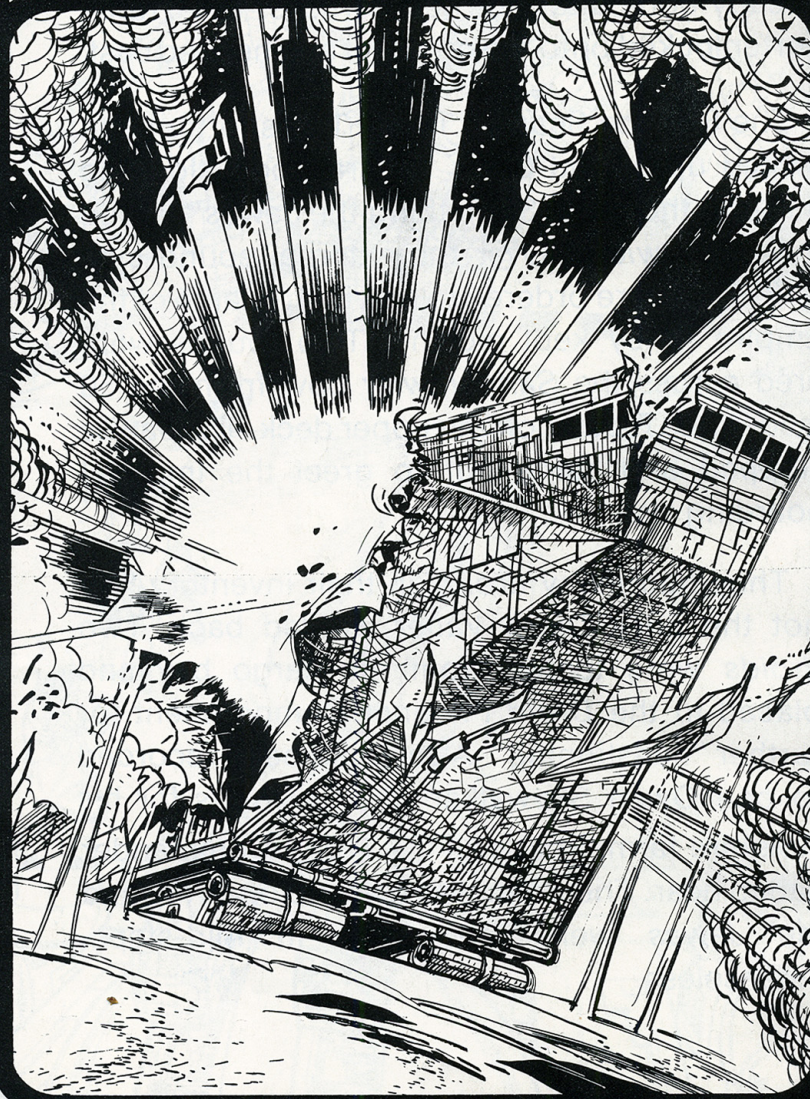

Kenner

©CPG PRODUCTS CORP. 1979 by its Div. KENNER PRODUCTS, Cincinnati, Ohio 45202

637-027-00



STAR WARS VISUAL GUIDES
WWW.JEDITEMPLEARCHIVES.COM